



VPi-4 iVacSens™ LT

OEM Vacuum transducer for system integration

1×10^{-6} to 13.33 mbar / 7.5×10^{-7} to 10 Torr

Ultra-compact wide range heat-loss MEMS Pirani transducer module

Advantages

- Wide measuring range of 7 decades
- Digital RS-485 serial interface
- Digital UART serial interface
- Analog voltage output
- 3 digital setpoint outputs for process control
- Remote zero adjustment
- Vacuum temperature sensor for diagnostics
- Ultra-compact design



The iVacSens™ Series vacuum transducer module is the world's smallest wide-range multi-function vacuum gauge.

The iVacSens™ functions as a full-featured traditional vacuum transducer and is delivered calibrated and ready to use.

It is designed for high-level equipment integration in instrumentation operated under vacuum, like mass spectrometers, leak detectors and scanning electron microscopes.

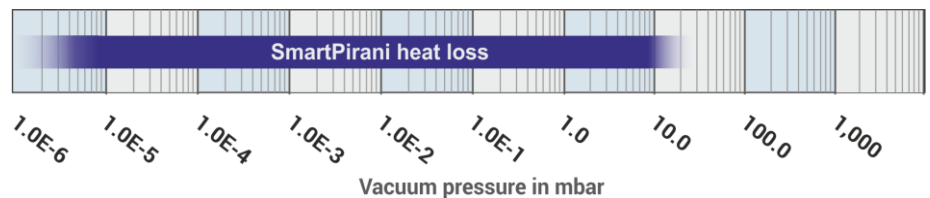

Applications

- Mass spectrometers
- Scanning electron microscopes
- Vacuum pump integration
- Valve integration
- Space flight
- Leak detection
- Flywheel energy storage
- Vacuum switch

The iVacSens™ is based on the proven record-breaking SmartPirani™ MEMS heat-loss sensor that offers best-in-class performance, wider measurement range and higher accuracy than traditional Pirani and convection gauges.

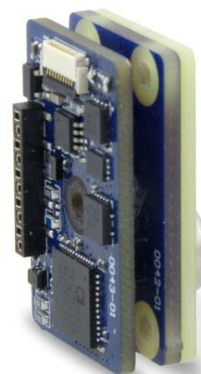

Multiparameter sensor solution

The iVacSens™ comprises a heat-loss MEMS Pirani sensor and a vacuum temperature sensor.

Sensor measurement values are accessible either through a UART or an RS-485 digital interface.

The temperature parameters can be used to provide warning or control signals to shut down equipment in the event of over-heating, or as a parameter for calculating predictive maintenance of the equipment.

Customized solution

The transducer module can be delivered with a custom configuration of setpoint switch values and other digital parameters.

For OEM customers Sens4 also offers customized installation flanges, interfaces, and digital protocols.

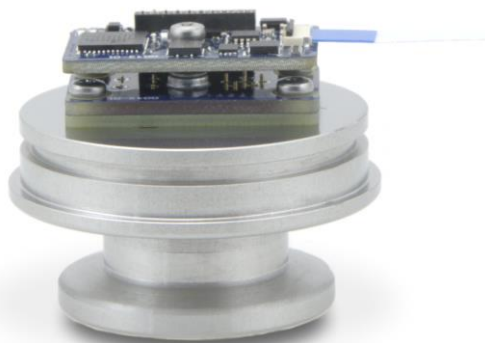

Getting started

The iVacSens™ evaluation kit enables users to seamlessly evaluate the features and measurement performance prior to integration in the equipment.

The evaluation kit offers USB connectivity and evaluation software.

The evaluation sensor module is mounted on a DN16KF vacuum flange for easy mounting to a vacuum system.

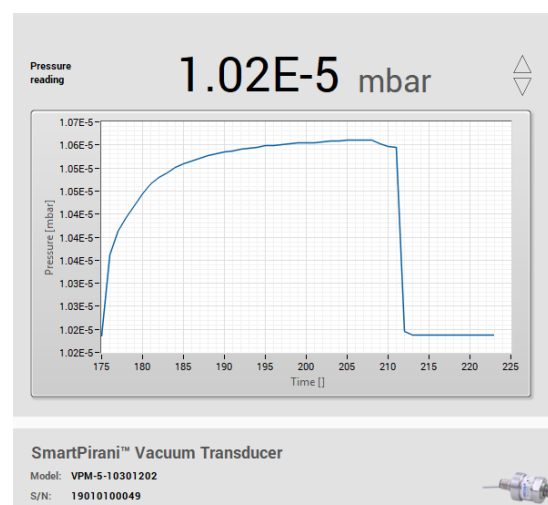

Flexible operation and configuration

The iVacSens™ offers multiple different analog and digital operation modes for flexible integration in customer equipment.

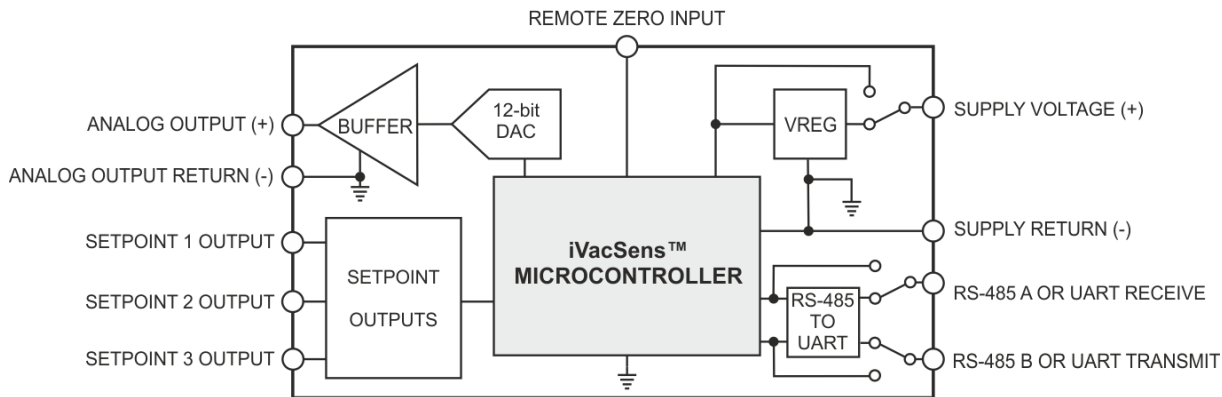

Analog voltage output

The standard analog voltage output provides a voltage signal of 150 mV/decade and can be interfaced to an external digital-to-analog converter.

Universal Asynchronous Receiver/Transmitter (UART)

The UART interface can be connected directly to a host microcontroller for digital acquisition of measurement data and configuration of the iVacSens™ transducer module.

RS-485 interface

The RS-485 interface allows multiple iVacSens™ devices to be connected in parallel, with individual addressing of each transducer. It is an easy, standardized interface to external devices. The communication protocol is compatible with the VPM-5 and VPM-7 SmartPirani™ transducer series.

Setpoint control

The three independent setpoints provide a means of digital signaling at user-defined pressure values. When using the setpoints the iVacSens™ transducer module can be used as a vacuum pressure switch to control the vacuum process or to ensure that an adequate vacuum level is achieved for turning on vacuum-operated devices like ion sources.

The switching function can also be used as a safety interlock switch.

Applications

Vacuum measurement is fundamental for operating many types of analytical and industrial vacuum-based equipment.

The iVacSens™ provides a ready-to-use solution for equipment integration and direct connectivity to equipment electronics and microcontrollers.

In space-constrained applications where traditional vacuum transducers and sensors might not be suitable, the iVacSens™ can eliminate time-consuming measurement electronics development and provide fast time to market with a well-proven, high-performance solution.

Analytical equipment

In many types of vacuum-operated analytical instrumentation, like mass spectrometers, vacuum gauges are used to determine safe operation of an equipment ion source.

In some applications, the ultra-wide range of the iVacSens™ can replace expensive high vacuum ionization gauges.



Spaceflight systems

The compact size, low weight, and small mass of iVacSens™ makes it well suited for demanding applications like space flight systems.

The novel MEMS sensor technology used in iVacSens™ can withstand continuous vibrations and high G-forces that are common during rocket launches.

Portable equipment

The small footprint, ultra-low power consumption and insensitivity to mounting position and vibrations makes iVacSens™ ideal for portable, battery-operated vacuum equipment and instrumentation.

Technical data

Specifications

Measuring range	1×10 ⁻⁶ to 13.33 mbar (7.5×10 ⁻⁷ to 10 Torr)
Measuring principle	1×10 ⁻⁶ to 13.3 mbar MEMS Pirani thermal conductivity
Accuracy	1×10 ⁻⁵ to 9.99×10 ⁻⁵ mbar 25% of reading
Accuracy	1×10 ⁻⁴ to 9.99×10 ⁻¹ mbar 5% of reading
Accuracy	1.0 to 10 mbar 30% of reading
Hysteresis	1×10 ⁻³ to 9.99×10 ⁻¹ mbar 1%
Hysteresis	1 to 10 mbar 10%
Vacuum temperature sensor range	-20 to + 85°C
Vacuum temperature sensor accuracy	+/- 1.5 °C
Transducer temperature sensor range	-20 to + 85°C
Transducer temperature sensor accuracy	+/- 1.5 °C
Analog output	0.2 – 1.55 VDC (150 mV/decade mbar/torr)
Analog output resolution	12 bit
Analog output update rate	124 Hz
Response time	<20 ms
Temperature compensation	+10 to +50 °C
Set point range (absolute)	5×10 ⁻⁶ to 13.33 mbar (3.75×10 ⁻⁶ to 10 Torr)
Setpoint output high level	>2.9 VDC
Setpoint output low level	<0.4 VDC
Setpoint output source and sink current	1 mA maximum

Environment conditions

Operating ambient temperature	-20 to +50 °C
Media temperature	-20 to +50 °C
Storage ambient temperature	-40 to +120 °C
Bake-out temperature (non-operating)	+120 °C
Maximum media pressure	10 bar absolute
Mounting position	Arbitrary
Protection rating, EN 60529/A2:2013	IP40
Humidity, IEC 68-2-38	98%, non-condensing

Power supply

Supply voltage	+3.3 VDC or 4-18 VDC
Power consumption	25 mW (max) 3.3 VDC supply 95 mW (max) 4-18 VDC supply
Reverse polarity protection	No
Overvoltage protection	No

Materials

Vacuum exposed materials (media wetted)	304 Stainless steel, Kovar, glass, silicon, nickel, aluminum, SiO ₂ , Si ₃ N ₄ , gold, low out-gassing epoxy resin, Viton ⁽¹⁾
Sensor leak tightness (ISO 27895:2009)	<1·10 ⁻⁹ mbar·l/s

Approvals

RoHS compliance	Directive EU 2015/863
-----------------	-----------------------

Specifications are subject to change without further notice

(1) Only applicable for surface mount version, Viton® is a trademark of THE CHEMOURS COMPANY FC, LLC

Connector Pin outs (10 pin 0.5 mm pitch FCC)

Pin	Description
1	Supply voltage – (return)
2	Supply voltage 3.3 VDC or 4-18 VDC ⁽²⁾
3	Analog voltage signal – (return)
4	Analog voltage signal +
5	Setpoint 3 output
6	Setpoint 2 output
7	Setpoint 1 output
8	UART receive or RS-485 B ⁽²⁾
9	UART transmit or RS-485 A ⁽²⁾
10	Remote Zero input

(2) Part number dependent

Dimensions

All dimensions in mm.

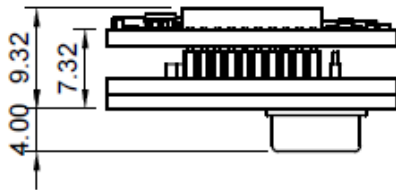

Dimensions with surface mount flange

All dimensions in mm.

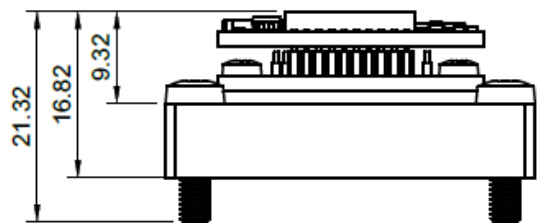
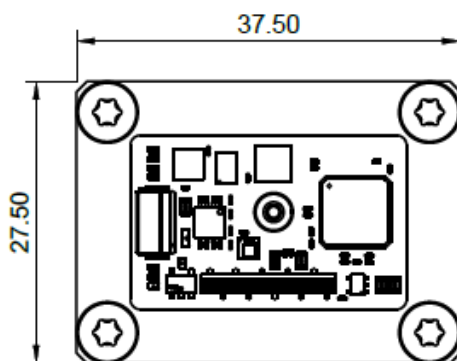

Order guide

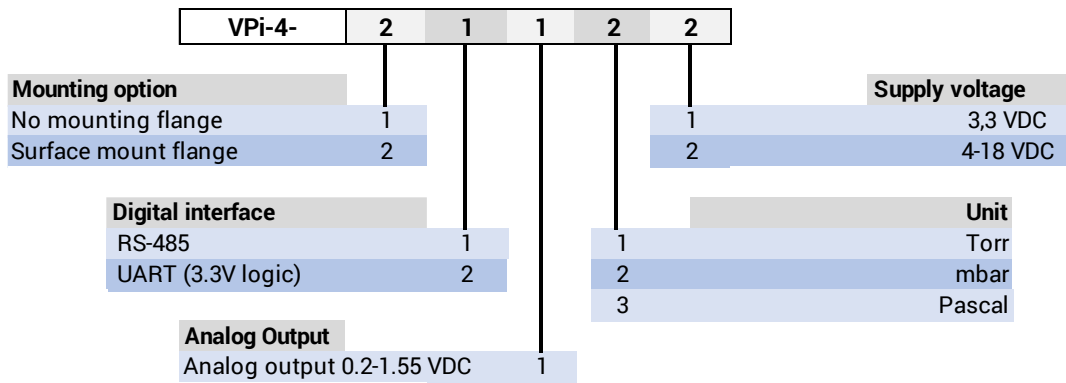

Evaluation kit

iVacSens™ Evaluation kits	Part number
VPi-4-12111 Evaluation kit USB, DN16KF	VPi-4-12111-EVL
VPi-4-12112 Evaluation kit USB, DN16KF	VPi-4-12112-EVL
VPi-4-12121 Evaluation kit USB, DN16KF	VPi-4-12121-EVL
VPi-4-12122 Evaluation kit USB, DN16KF	VPi-4-12122-EVL
VPi-4-12131 Evaluation kit USB, DN16KF	VPi-4-12131-EVL
VPi-4-12132 Evaluation kit USB, DN16KF	VPi-4-12132-EVL
VPi-4-13111 Evaluation kit USB, DN16KF	VPi-4-13111-EVL
VPi-4-13112 Evaluation kit USB, DN16KF	VPi-4-13112-EVL
VPi-4-13121 Evaluation kit USB, DN16KF	VPi-4-13121-EVL
VPi-4-13122 Evaluation kit USB, DN16KF	VPi-4-13122-EVL
VPi-4-13131 Evaluation kit USB, DN16KF	VPi-4-13131-EVL
VPi-4-13132 Evaluation kit USB, DN16KF	VPi-4-13132-EVL

Accessories

iVacSens™ connection cables	Part number
FCC flat cable 0.5 mm pitch 10 pin 30 mm length	CAB-FCC10P-030
FCC flat cable 0.5 mm pitch 10 pin 50 mm length	CAB-FCC10P-050
FCC flat cable 0.5 mm pitch 10 pin 100 mm length	CAB-FCC10P-100
FCC flat cable 0.5 mm pitch 10 pin 150 mm length	CAB-FCC10P-150
FCC flat cable 0.5 mm pitch 10 pin 200 mm length	CAB-FCC10P-200
FCC flat cable 0.5 mm pitch 10 pin 300 mm length	CAB-FCC10P-300

Other iVacSens™ Series products

The VPi iVacSens™ includes the VPi-5 with MEMS Pirani sensor and piezo diaphragm and VPi-7 with MEMS Pirani, piezo diaphragm sensor and atmospheric switch function. For more information visit www.sens4.com/ivacsens-series/

About

Sens4 develops, manufactures, markets, and distributes vacuum, pressure and temperature measuring equipment for industrial applications worldwide. Our products are designed, engineered, and manufactured in Denmark to the highest quality standards. Our mission is to continuously endeavor to provide customer centric state of the art measurement solutions.

Our passion | Your value™

