



# VPi-7 iVacSens™ ATM

OEM Vacuum transducer for system integration

1×10<sup>-6</sup> to 1,333 mbar / 7.5×10<sup>-7</sup> to 1,000 Torr

Ultra-compact wide range pirani / piezo transducer module with atmospheric switch function

## Advantages

- Ultra-wide measuring range of 9 decades
- Precision atmospheric switch function
- Barometric pressure measurement
- Digital RS-485 serial interface
- Digital UART serial interface
- Analog voltage output
- 3 digital setpoint outputs for process control
- Remote zero adjustment
- Vacuum temperature sensor for diagnostics
- Ultra-compact design



The iVacSens™ Series vacuum transducer module is the world's smallest wide-range multi-function combination vacuum gauge. The iVacSens™ functions as a full-featured traditional vacuum transducer and is delivered calibrated and ready to use.

It is designed for high-level equipment integration in instrumentation operated under vacuum, like mass spectrometers and scanning electron microscopes.

The iVacSens™ is based on the proven record-breaking SmartPirani™ MEMS heat-loss sensor that offers best-in-class performance, wider measurement range and higher accuracy than traditional Pirani and convection gauges. The SmartPirani™ sensor technology is combined with a diaphragm sensor, which offers gas-independent measurements from 2 to 1,333 mbar.

## Applications

- Mass spectrometers
- Scanning electron microscopes
- Vacuum pump integration
- Valve integration
- Space flight
- Leak detection
- Flywheel energy storage
- Vacuum switch

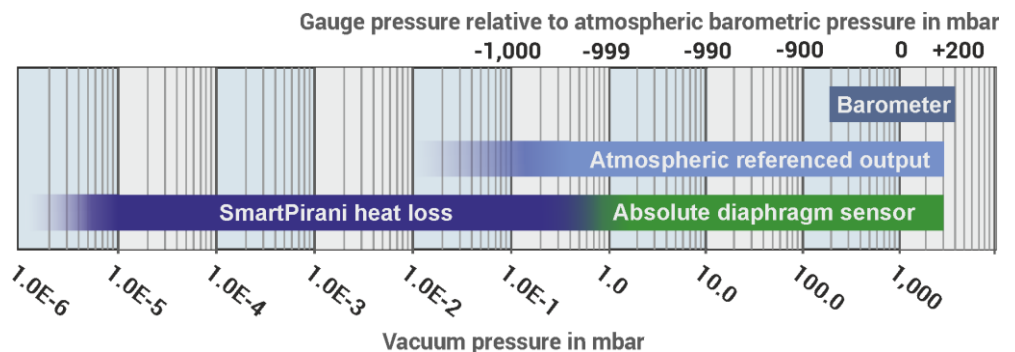

Furthermore, the iVacSens™ ATM has a built-in atmospheric switch function that enables accurate control of vacuum system venting to atmospheric pressure by measuring relative to barometric pressure.

## Multiparameter sensor solution

The iVacSens™ ATM comprises a heat-loss MEMS Pirani sensor, an absolute diaphragm sensor, a barometric sensor, a vacuum temperature sensor and an ambient temperature sensor.

All sensor measurement values are accessible either through a UART or an RS-485 digital interface.

The temperature parameters can be used to provide warning or control signals to shut down equipment in the event of over-heating, or as a parameter for calculating predictive maintenance of the equipment.

## Customized solution

The transducer module can be delivered with a custom configuration of setpoint switch values and other digital parameters.

For OEM customers Sens4 also offers customized installation flanges, interfaces, and digital protocols.

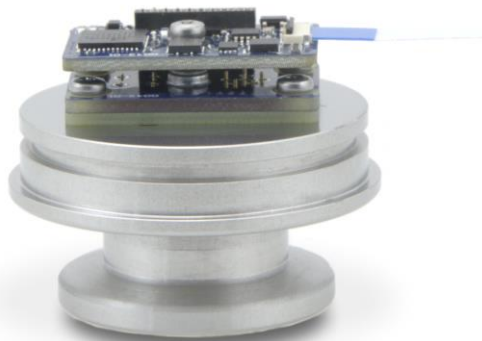

## Getting started

The iVacSens™ evaluation kit enables users to seamlessly evaluate the features and measurement performance prior to integration in the equipment.

The evaluation kit offers USB connectivity and evaluation software.

The evaluation sensor module is mounted on a DN16KF vacuum flange for easy mounting to a vacuum system.

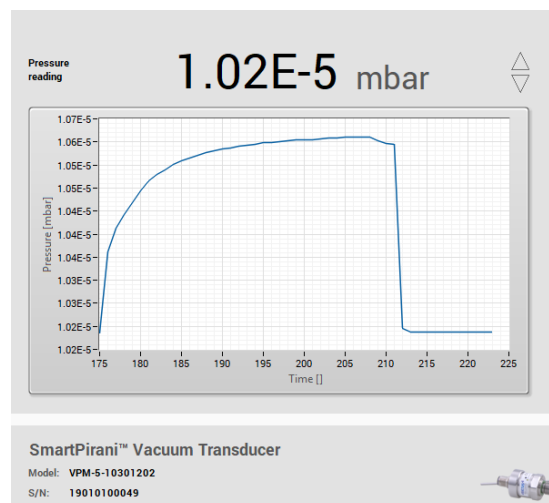

## Flexible operation and configuration

The iVacSens™ offers multiple different analog and digital operation modes for flexible integration in customer equipment.

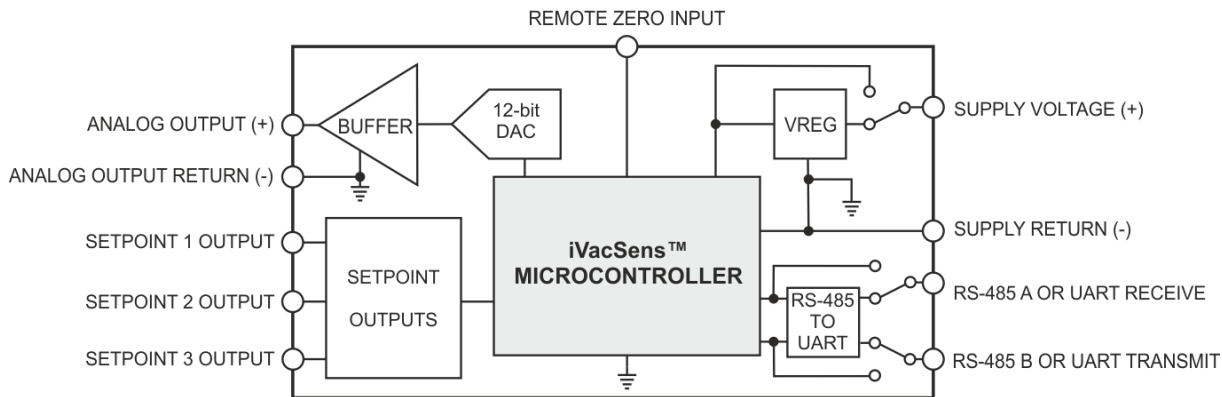

### Analog voltage output

The standard analog voltage output provides a voltage signal of 150 mV/decade and can be interfaced to an external digital-to-analog converter.

### Universal Asynchronous Receiver/Transmitter (UART)

The UART interface can be connected directly to a host microcontroller for digital acquisition of measurement data and configuration of the iVacSens™ transducer module.

### RS-485 interface

The RS-485 interface allows multiple iVacSens™ devices to be connected in parallel, with individual addressing of each transducer. It is an easy, standardized interface to external devices. The communication protocol is compatible with the VPM-5 and VPM-7 SmartPirani™ transducer series.

### Setpoint control

The three independent setpoints provide a means of signaling at user-defined pressure values. When using the setpoints the iVacSens™ transducer module can be used as a pressure switch to control the vacuum process or to ensure that an adequate vacuum level is achieved for turning on vacuum-operated devices like ion sources.

The switching function can also be used as a safety interlock switch.

## Applications

Vacuum measurement is fundamental for operating many types of analytical and industrial vacuum-based equipment.

The iVacSens™ ATM provides a ready-to-use solution for equipment integration and direct connectivity to equipment electronics and microcontrollers.

In space-constrained applications where traditional vacuum transducers and sensors might not be suitable, the iVacSens™ can eliminate time-consuming measurement electronics development and provide fast time to market with a well-proven, high-performance solution.

### Analytical equipment

In many types of vacuum-operated analytical instrumentation, like mass spectrometers, vacuum gauges are used to determine safe operation of an equipment ion source.

In some applications, the ultra-wide range of the iVacSens™ can replace expensive high vacuum ionization gauges.



### Spaceflight systems

The compact size, low weight, and small mass of iVacSens™ makes it well suited for demanding applications like space flight systems.

The novel MEMS sensor technology used in iVacSens™ can withstand continuous vibrations and high G-forces that are common during rocket launches.

### Portable equipment

The small footprint, ultra-low power consumption and insensitivity to mounting position and vibrations makes iVacSens™ ideal for portable, battery-operated vacuum equipment and instrumentation.

# Technical data

Specifications	
Measuring range	1×10 <sup>-6</sup> to 1,333 mbar (7.5×10 <sup>-7</sup> to 1000 Torr)
Measuring principle 1×10 <sup>-6</sup> to 1.5 mbar	MEMS Pirani thermal conductivity
Measuring principle 1.5 to 2 mbar	Blended MEMS Pirani / piezo reading
Measuring principle 2 to 1,333 mbar	MEMS piezo resistive diaphragm
Accuracy 1×10 <sup>-5</sup> to 9.99×10 <sup>-5</sup> mbar	25% of reading
Accuracy 1×10 <sup>-4</sup> to 9.99 mbar	5% of reading
Accuracy 10.0 to 99.9 mbar	1% of reading
Accuracy 100 to 800 mbar	0.5% of reading
Accuracy 800 to 1,099 mbar	0.25% of reading
Accuracy 1,100 to 1,200 mbar	0.5% reading
Hysteresis 1×10 <sup>-3</sup> to 10 mbar (ISO 19685:2017)	1%
Hysteresis 10 to 1,200 mbar (ISO 19685:2017)	0.1%
Barometric measurement range	300 to 1,200 mbar
Barometric accuracy	+/- 0.5 mbar
Atmospheric referenced pressure output range	-1,333 to + 1,333 mbar
Vacuum temperature sensor range	-20 to + 85°C
Vacuum temperature sensor accuracy	+/- 1.5 °C
Transducer temperature sensor range	-20 to + 85°C
Transducer temperature sensor accuracy	+/- 1.5 °C
Analog output	0.2 to 1.55 VDC (150 mV/decade mbar/torr)
Analog output resolution	12 bit
Analog output update rate	124 Hz
Response time	<20 ms
Temperature compensation	+10 to +50 °C
Set point range (absolute)	5×10 <sup>-6</sup> to 1,333 mbar (3.75×10 <sup>-6</sup> to 1000 Torr)
Set point range (atm. relative)	-1,100 to + 500 mbar (-770 to +375 Torr)
Setpoint output high level	>2.9 VDC
Setpoint output low level	<0.4 VDC
Setpoint output source and sink current	1 mA maximum
Environment conditions	
Operating ambient temperature	-20 to +50 °C
Media temperature	-20 to +50 °C
Storage ambient temperature	-40 to +120 °C
Bake-out temperature (non-operating)	+120 °C
Maximum media pressure	10 bar absolute
Mounting position	Arbitrary
Protection rating, EN 60529/A2:2013	IP40
Humidity, IEC 68-2-38	98%, non-condensing
Power supply	
Supply voltage	+3.3 VDC or 4-18 VDC
Power consumption	25 mW (max) 3.3 VDC supply 95 mW (max) 4-18 VDC supply
Reverse polarity protection	No
Overvoltage protection	No

Specifications are subject to change without further notice

# Technical data

## Materials

Vacuum exposed materials (media wetted)

304 Stainless steel, Kovar, glass, silicon, nickel, aluminum, SiO<sub>2</sub>, Si<sub>3</sub>N<sub>4</sub>, gold, low out-gassing epoxy resin, solder, RO4305, Viton<sup>(1)</sup>

Sensor leak tightness (ISO 27895:2009)

<1·10<sup>-9</sup> mbar·l/s

## Approvals

RoHS compliance

Directive EU 2015/863

Specifications are subject to change without further notice  
LLC

(1) Only applicable for surface mount version, Viton® is a trademark of THE CHEMOURS COMPANY FC,

## Connector Pin outs (10 pin 0.5 mm pitch) FCC)

Pin	Description
1	Supply voltage – (return)
2	Supply voltage 3.3 VDC or 4-18 VDC <sup>(2)</sup>
3	Analog voltage signal – (return)
4	Analog voltage signal +
5	Setpoint 3 output
6	Setpoint 2 output
7	Setpoint 1 output
8	UART receive or RS-485 B <sup>(2)</sup>
9	UART transmit or RS-485 A <sup>(2)</sup>
10	Remote Zero input

(2) Part number dependent

## Dimensions

All dimensions in mm.

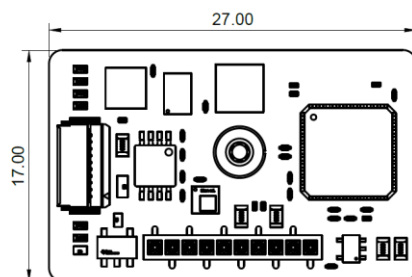
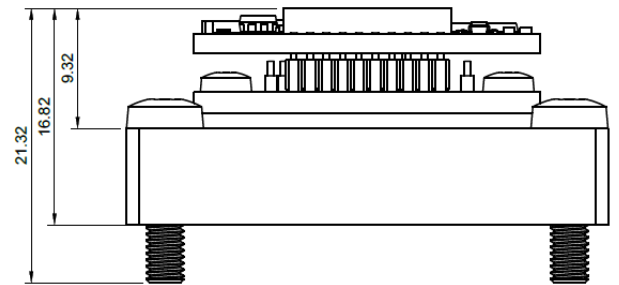
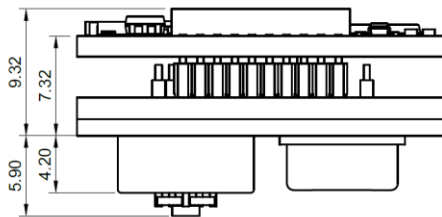

iVacSens™ module

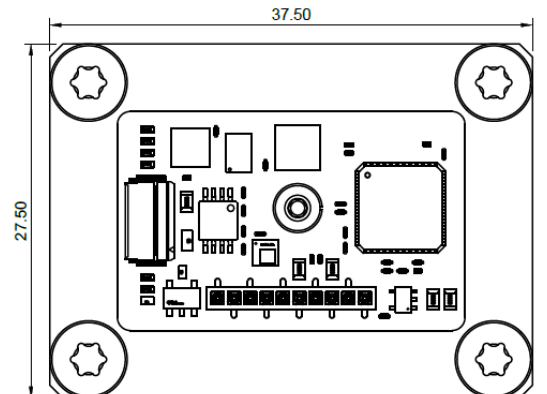

iVacSens™ module with surface mount flange

# Order guide

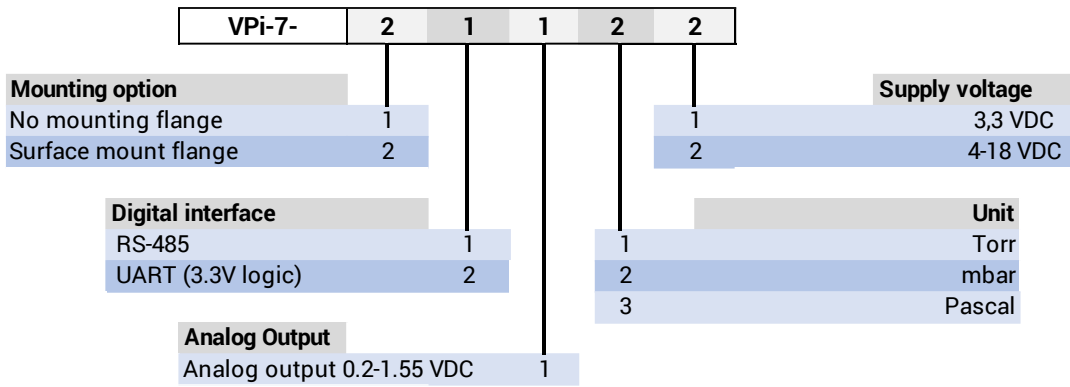

## Evaluation kit

iVacSens™ Evaluation kits	Part number
VPi-7-12111 Evaluation kit USB, DN16KF	VPi-7-12111-EVL
VPi-7-12112 Evaluation kit USB, DN16KF	VPi-7-12112-EVL
VPi-7-12121 Evaluation kit USB, DN16KF	VPi-7-12121-EVL
VPi-7-12122 Evaluation kit USB, DN16KF	VPi-7-12122-EVL
VPi-7-12131 Evaluation kit USB, DN16KF	VPi-7-12131-EVL
VPi-7-12132 Evaluation kit USB, DN16KF	VPi-7-12132-EVL
VPi-7-13111 Evaluation kit USB, DN16KF	VPi-7-13111-EVL
VPi-7-13112 Evaluation kit USB, DN16KF	VPi-7-13112-EVL
VPi-7-13121 Evaluation kit USB, DN16KF	VPi-7-13121-EVL
VPi-7-13122 Evaluation kit USB, DN16KF	VPi-7-13122-EVL
VPi-7-13131 Evaluation kit USB, DN16KF	VPi-7-13131-EVL
VPi-7-13132 Evaluation kit USB, DN16KF	VPi-7-13132-EVL

## Accessories

iVacSens™ connection cables	Part number
FCC flat cable 0.5 mm pitch 10 pin 30 mm length	CAB-FCC10P-030
FCC flat cable 0.5 mm pitch 10 pin 50 mm length	CAB-FCC10P-050
FCC flat cable 0.5 mm pitch 10 pin 100 mm length	CAB-FCC10P-100
FCC flat cable 0.5 mm pitch 10 pin 150 mm length	CAB-FCC10P-150
FCC flat cable 0.5 mm pitch 10 pin 200 mm length	CAB-FCC10P-200
FCC flat cable 0.5 mm pitch 10 pin 300 mm length	CAB-FCC10P-300

## Other iVacSens™ Series products

The VPi iVacSens™ includes the VPi-4 with MEMS Pirani sensor only and VPi-5 with MEMS Pirani and Piezo diaphragm sensor.

## About

Sens4 develops, manufactures, markets, and distributes vacuum, pressure and temperature measuring equipment for industrial applications worldwide. Our products are designed, engineered, and manufactured in Denmark to the highest quality standards. Our mission is to continuously endeavor to provide customer centric state of the art measurement solutions.

Our passion | Your value™

